

Pumper Operations

Introductory Drill Night

Version Feb 2016

TEXAS A&M FOREST SERVICE



NOTICE

This course is not designed to meet any certification requirements and is not intended to present comprehensive information. It is designed to present a brief introduction and overview of information for introductory use.

Texas A&M Forest Service recommends all firefighting personnel receive training that meets recognized standards before working in the fire ground environment.

Course Outline

- Unit 1 Characteristics of Water
- Unit 2 Pump Construction & Gauges
- Unit 3 Friction Loss
- Unit 4 Operational Practices



Unit 1

CHARACTERISTICS OF WATER

Unit Objectives

1. Identify common characteristics of water.
2. Identify what water hammer is and how to prevent it.
3. Identify what cavitation is and how to prevent it.

Unit Objectives

4. Understand Pounds per Square Inch.
5. Describe Atmospheric Pressure and Vacuum.
6. Describe Static Pressure.
7. Describe Residual Pressure.

Water

- Most frequently used extinguishing agent
- Very abundant
- Relatively inexpensive compared to other types of fire extinguishing media

In order for us to use water as our primary ammunition in our firefighting arsenal, we must know some important basics about water.



Water

- Water *freezes* at 32° Fahrenheit (0° Celsius)
- Water *boils* at 212° Fahrenheit (100° Celsius)

This makes water a good extinguishing agent.

We use water to absorb heat release from fire. The energy from the fire is imparted into the water and the water changes to steam.

A great amount of energy is required to turn water from a liquid state to a vapor state.



Water

Water weighs approximately **8.3 pounds per gallon.**

This is important because our fire apparatus have the ability to pump on average up to 1,000 gallons per minute (gpm) at a large fire.

That means that every minute we are adding up to four tons of water into a structure and therefore building collapse is a real potential.



Water Hammer

Water is non-compressible.

This is the primary reason that you are told to open and close nozzles and gate valves slowly. Water moving through hose has a lot of inertia and energy.



Water Hammer

If you are supplying a 2½” hose line flowing 200 gpm, you are moving over 1,600 pounds of water every minute.

If the nozzle is slammed shut, the water in the hose will still be moving. The inertia of this moving water, being non-compressible, has the potential to cause severe damage and injury.

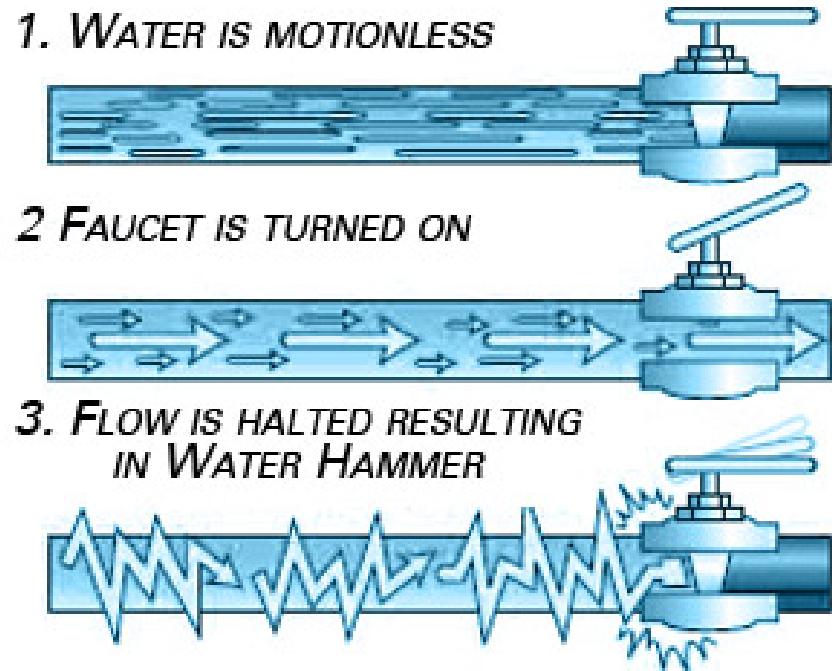

This is known as ***water hammer***.

Water Hammer

This damage will typically result in a broken hose line since this is usually the weakest point in the system.

This can mean the loss of water to firefighters who are utilizing hand lines.



Water

When using a fire department pump we can also impart a lot of heat into the water if our pump is left to run at Churn.

This means we are in pump gear with the impeller turning but we are not flowing water.

Water

If a line were to burst or someone removed a cap and opened a valve they could be burned or scalded by the hot water.

We must always remember to circulate water when in pump gear.

This can be done by tank to pump and tank fill or by discharging a small trickle of water onto the ground.

Water

We can also damage the pump by trying to pump more water out than what we have coming in.



Cavitation

The impellers are typically made of cast bronze.

Inside the impeller casting there are microscopic air pockets from the casting process.

If we spin the impeller too fast, usually when we try to pump more water than what we have, we create low pressure areas around the impeller.

Rotation
of Impeller

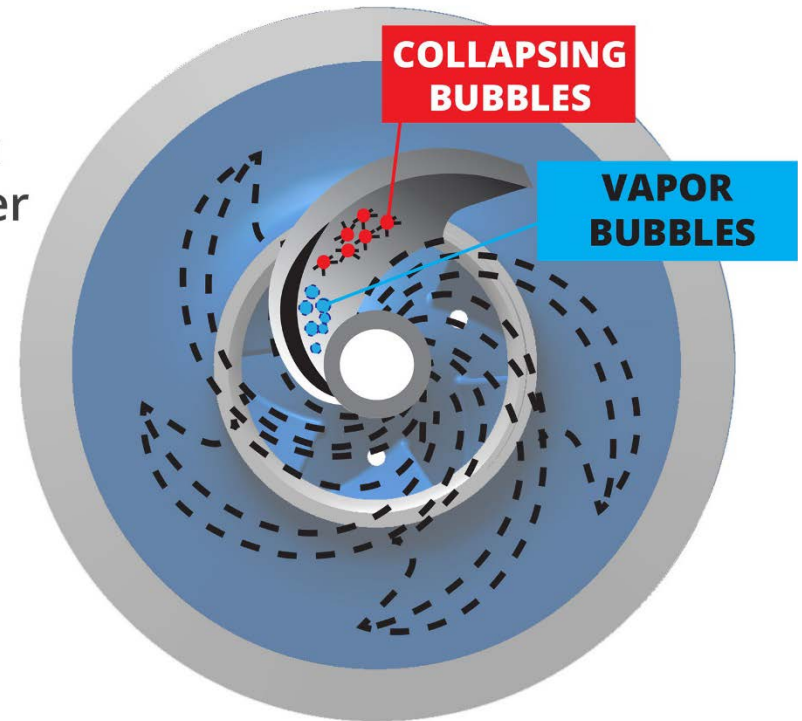

Cavitation

These low pressure areas can cause the air pockets in the casting to expand and flake off tiny pieces of the bronze impeller.

This condition is also known as *cavitation*.

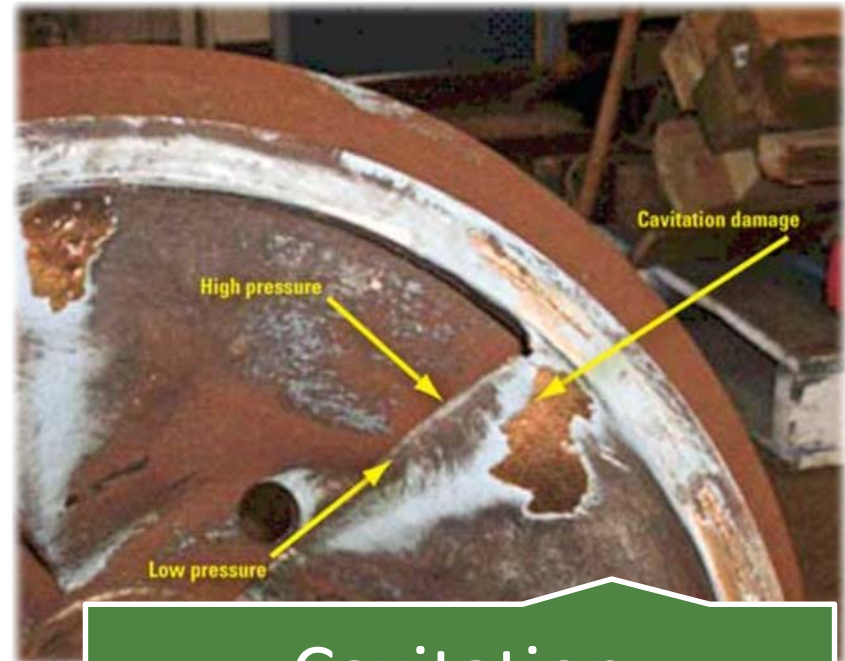

Cavitation
Damage

Cavitation

To prevent cavitation, do not attempt to pump more water than you have available.

If you begin to experience cavitation, reduce the amount of water you are trying to flow.



Pounds per Square Inch (psi)

When we look at or read a pressure gauge, we usually give the reading in pounds per square inch (psi).

This term comes from the weight of water in one cubic foot of water.



Pounds per Square Inch (psi)

The laws of hydraulics state that a column of water one foot high will exert a weight of 0.434 pounds at its base.

For ease of calculations, we can round 0.434 up to 0.5 or $\frac{1}{2}$ pound per foot of a column of water.

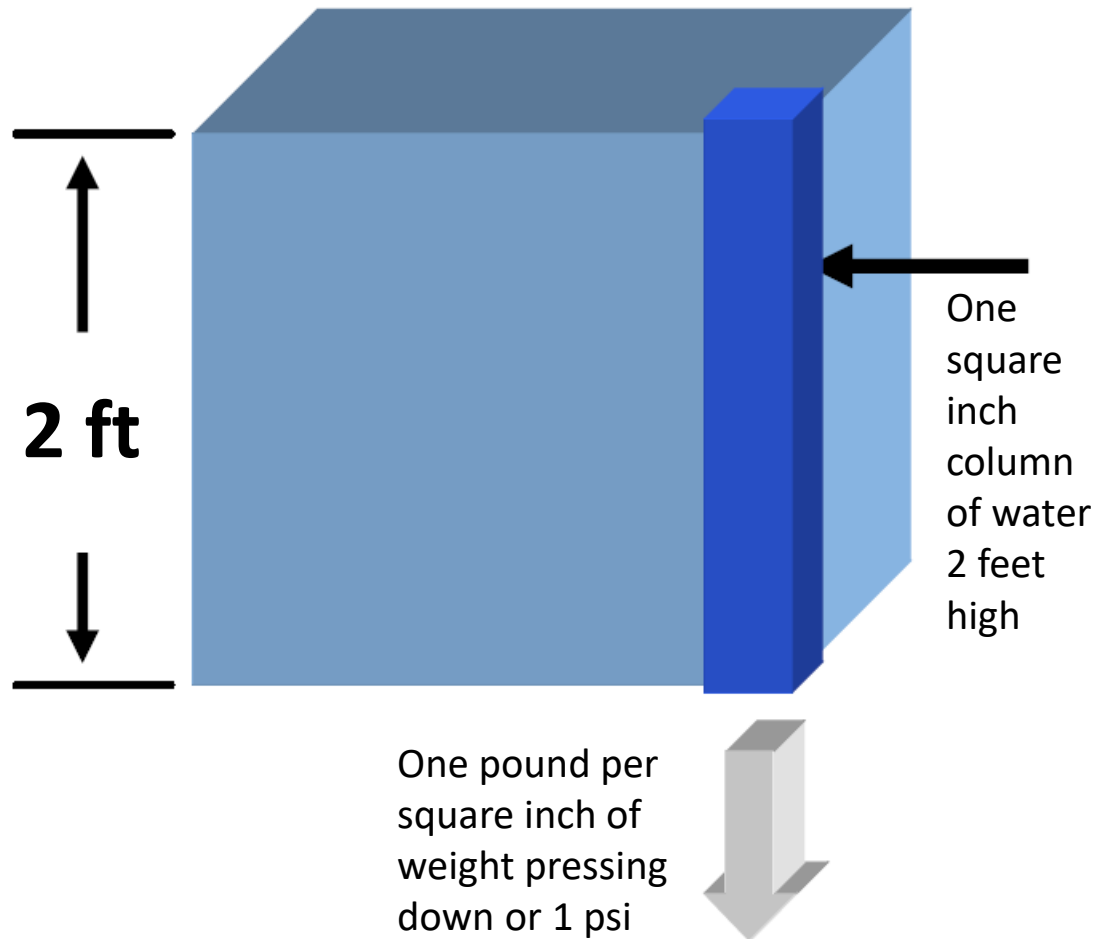

Six Principles of Fluid Pressure

Before we talk about the different kinds of pressure, it is important that we are aware of the six principles of fluid pressure.

1. Liquid pressure is exerted in a perpendicular direction to any surface on which it acts.
2. At any given point beneath the surface of a liquid, the pressure is the same in all directions: downward, upward and sideways.

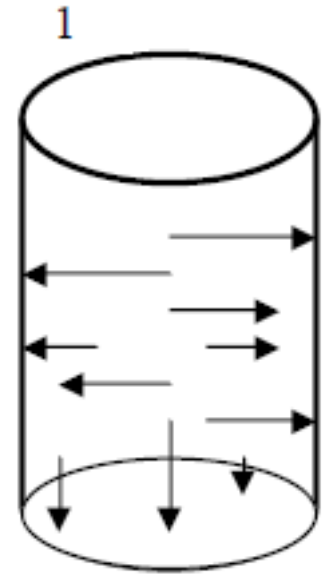

Six Principles of Fluid Pressure

3. Pressure applied to a confined liquid from without is transmitted in all directions without a reduction in intensity.

4

4. The pressure of a liquid in an open vessel is proportional to the depth of the liquid.

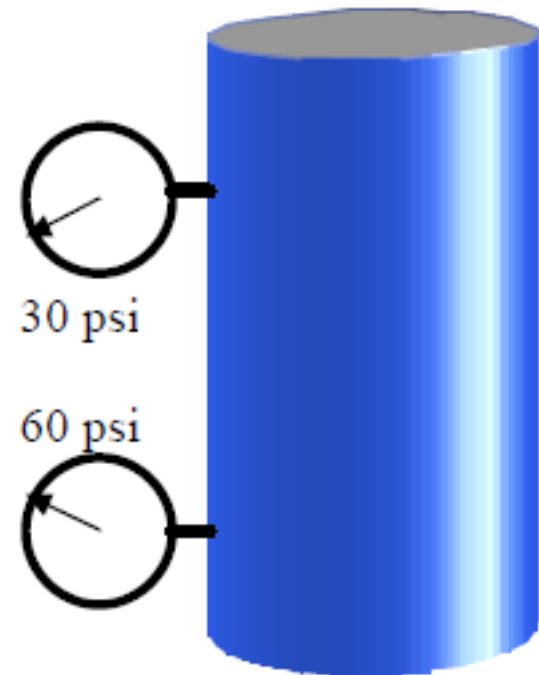

22

Six Principles of Fluid Pressure

5. The pressure of a liquid in an open vessel is proportional to the density of the liquid.
6. Liquid pressure on the bottom of a vessel is unaffected by the size and shape of the vessel.

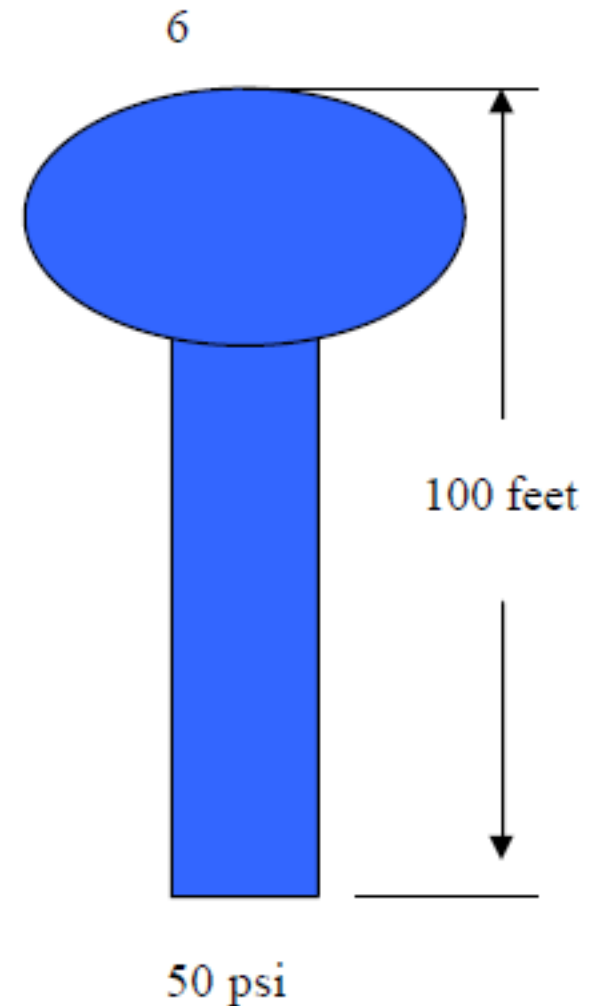

Atmospheric Pressure

Atmospheric pressure is the air pressure that is on everything on Earth. At this very instant, there is a force of 14.7 psi pressing against our bodies and all other objects (at sea level).

This atmospheric pressure is important when it comes to understanding how we *draft* water.

Pressures that are less than atmospheric are called *Vacuum*.

Atmospheric pressure is also known as *ambient pressure*.

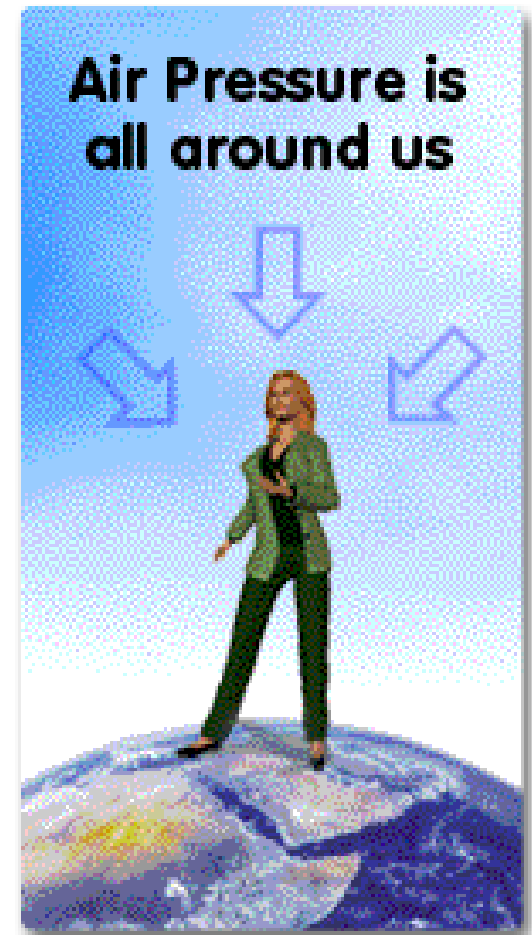

Static Pressure

The word static means stationary or no movement.

The reading of 50 psi on the water gauge at the base of the water tank is called a *static pressure* reading because there is no water flowing in the system.

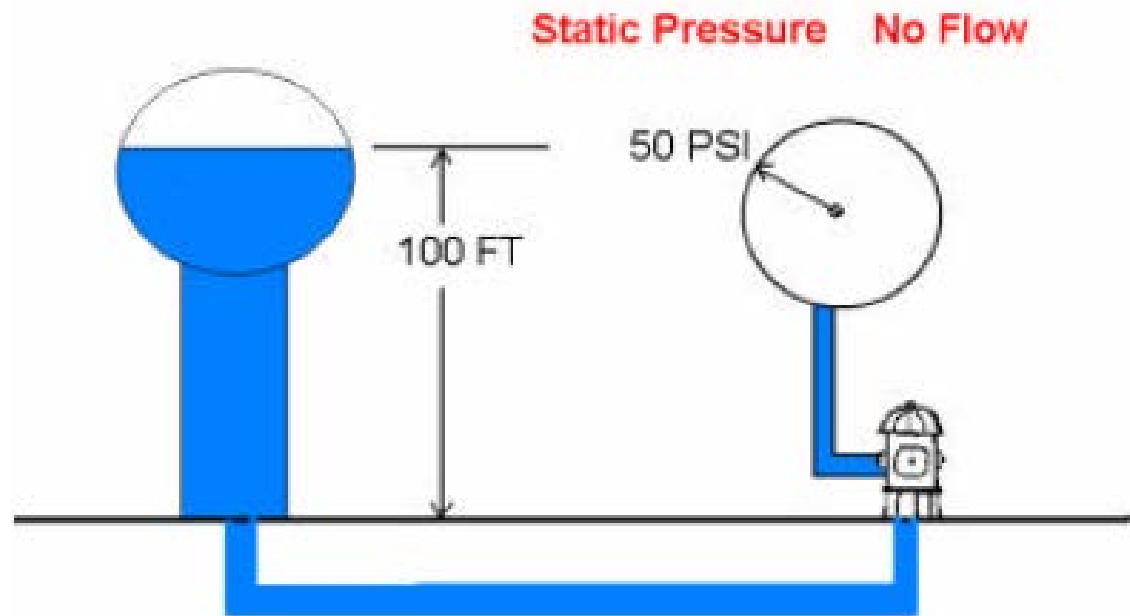

Residual Pressure

Residual or residue means what is left over. *Residual pressure* is the pressure on a gauge when water is in motion.

If we opened the hydrant to let water flow from the system our pressure gauge would drop. The pressure reading

when water is flowing is known as residual pressure.

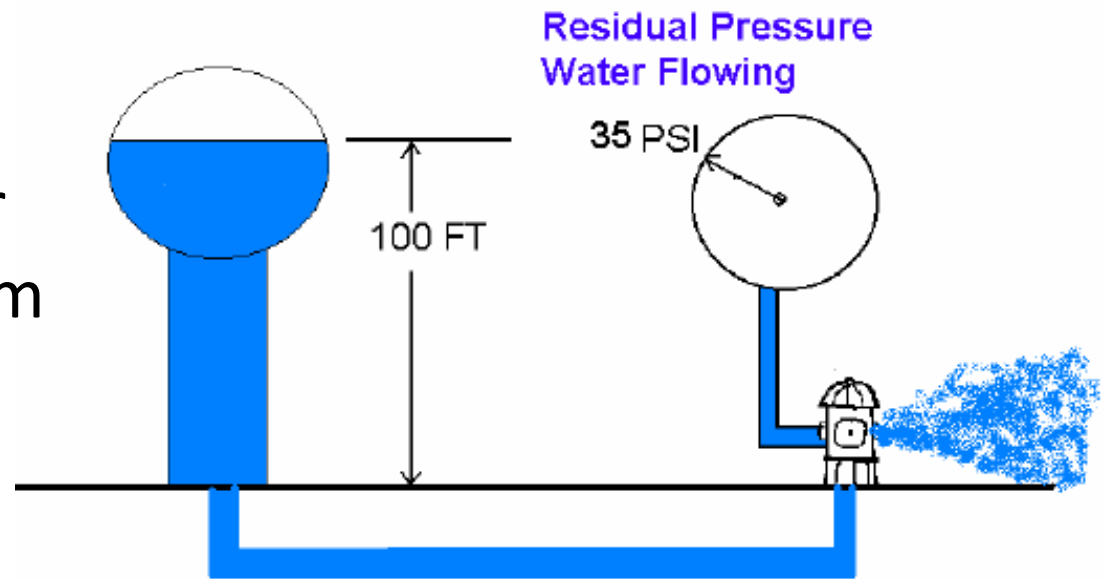

Unit 1 – Review

How much does one gallon of water weigh?

Approximately 8.3 pounds

How much does the water in a full 300 gallon tank weigh?

Approximately 2,490 pounds; over 1 ton

How can you prevent water hammer?

Slowly open and close valves

Unit 1 – Review

What is cavitation?

Areas of low pressure around the impeller

What causes cavitation?

Attempting to flow more water than is available

How can you stop cavitation?

Reduce the amount of water you are trying to flow

Unit 1 – Review

How much does water one foot high weigh per square inch?

Approximately $\frac{1}{2}$ (or 0.5) pound

How many psi does water 100 feet high weigh?

Approximately 50 psi

What is the air pressure that is on everything known as?

Atmospheric pressure or ambient pressure

Unit 1 – Review

What is the term for pressure less than Atmospheric Pressure?

Vacuum

What is the pressure at the bottom of a water tank where no water is moving known as?

Static pressure

What is the pressure left over when water is flowing known as?

Residual pressure

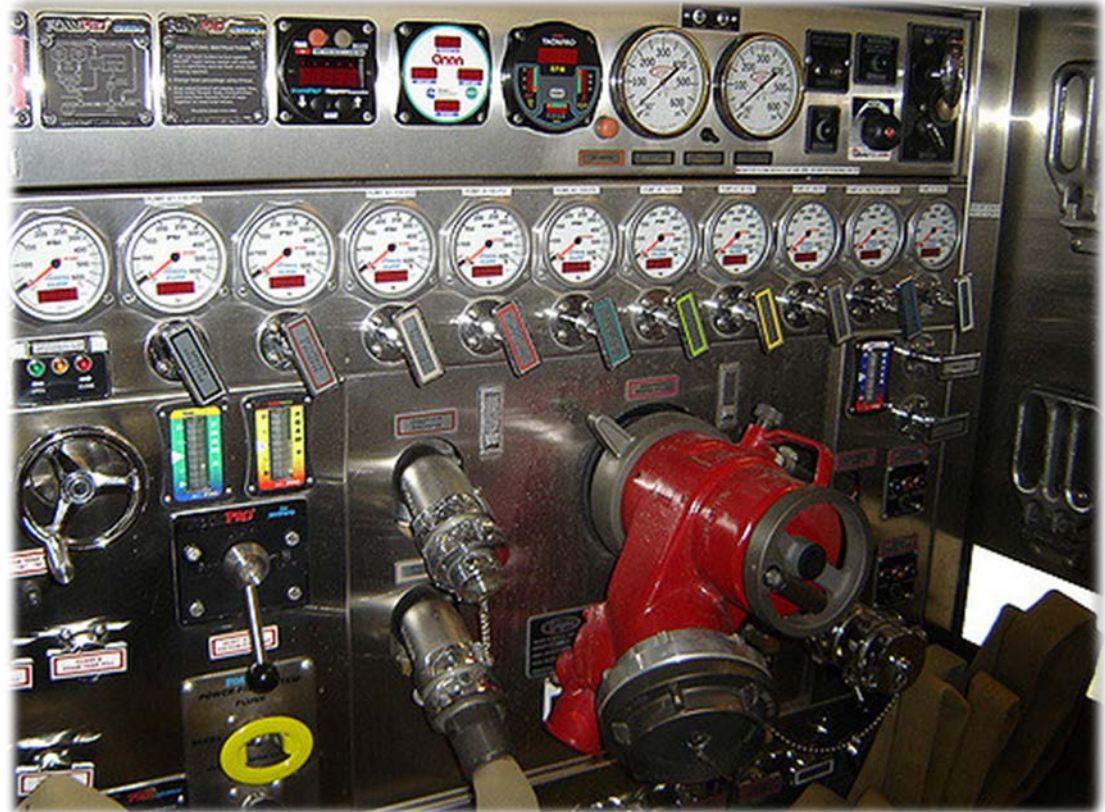

Unit 2

PUMP CONSTRUCTION AND GAUGES

Unit Objectives

1. Identify the structure of common fire pumps.
2. Identify the purpose and function of priming pumps.
3. Identify the gauges on a pump panel and understand their purposes.

Pump Construction & Gauges

Now that we know a little something about water, we can learn about the equipment needed to move that water.

Although there are several classifications of fire service pumps, we will concern ourselves with one specific type: mobile fire pumps.



Pump Construction & Gauges

For our purposes, mobile fire pumps are mounted on fire apparatus. They receive power from the vehicle's engine which is transmitted through the transmission.

These pumps come in several capacities, including 500 gpm, 750 gpm, 1,000 gpm, 1,250 gpm, 1,500 gpm and 2,000 gpm, and many more.

The most common type of fire pump found today is the centrifugal pump.



Centrifugal Pump

This pump is the workhorse of the fire service.

Its greatest advantage is that it takes advantage of positive pressure.

A disadvantage of the centrifugal pump is that it cannot pump air. Therefore we provide a smaller pump called a primer pump to help our centrifugal pump. This primer pump will be discussed later.

The most common centrifugal pump that we will deal with is the **single-stage centrifugal pump**.

There are also **multi-stage centrifugal pumps**. If you have a multi-stage centrifugal pump, additional training will be required.

Single-Stage Centrifugal Pump

The centrifugal pump consists of an impeller which is usually made of bronze. The impeller is mounted on a shaft at the center of the pump. The impeller's job is to take incoming water, at low pressure, and shoot it out at a higher, more usable pressure for firefighting.

Each impeller is situated in its own housing.

The single-stage fire pump only has one impeller which is usually larger than the impellers in a multi-stage pump.

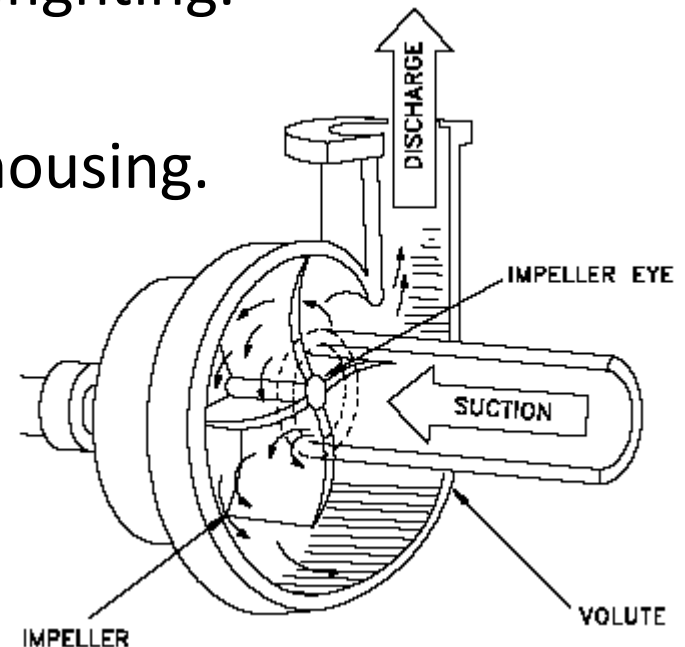

Single-Stage Centrifugal Pump

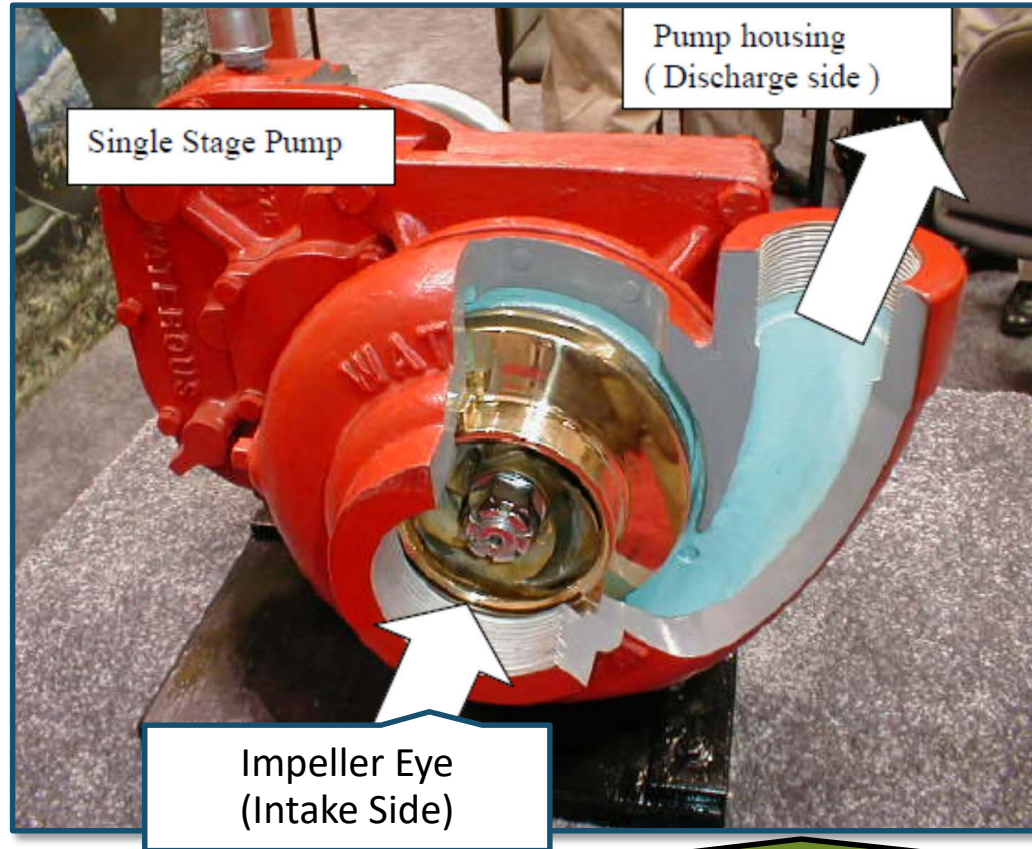

Water enters pump through the impeller eye and is discharged through the volute.

Priming Systems

As mentioned before, the centrifugal pump cannot pump air. This becomes an important factor when it comes to drafting and even draining tank to pump operations.

When drafting, air must be expelled from the centrifugal pump or damage can occur.

This is accomplished by using a priming device. The priming device used is called a priming pump. Priming pumps are positive displacement pumps.

The two most common types of positive displacement pumps are **rotary gear** and **rotary vane**.

Priming Pumps

The rotary vane pump is driven by an electric motor and has been in use with centrifugal pumps since 1912.

The priming pump can pump air.

Many priming pumps have an oil tank connected to the priming pump, but some newer models are “oil-free.”

In those that use oil, it is used for sealing and lubricating during the priming process.

The priming pump is used to expel air from the centrifugal pump.

Priming Pumps

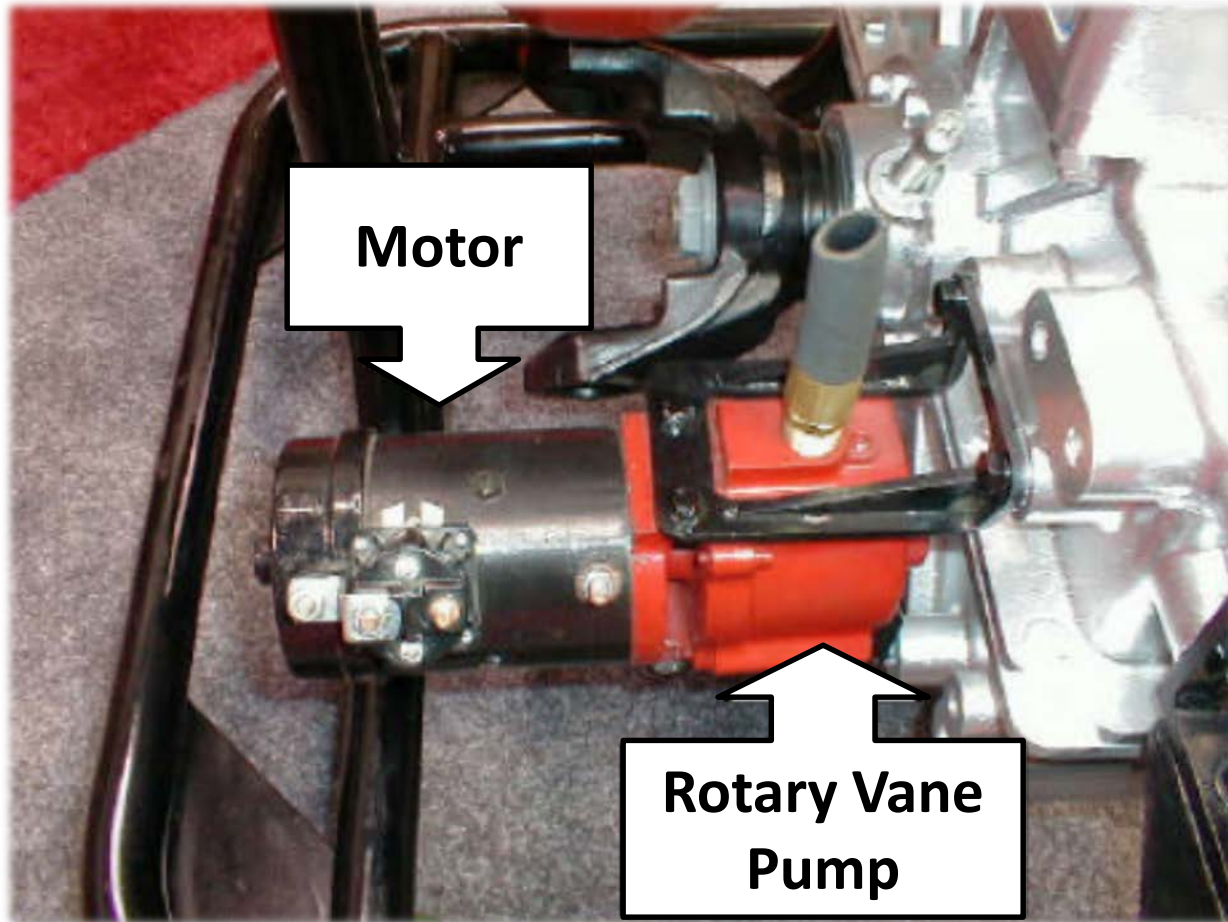

Relief Valve & Pressure Governors

Relief valves and pressure governors are used to prevent excess water pressure from being transferred to hand lines and other hose lines.

The relief valve and pressure governors are primarily used when more than one hose line is in operation.



If one nozzle is shut down, the excess pressure will be redirected to the hose line still operating if the relief valve is not set.



Relief Valve & Pressure Governors

The relief valve is a spring operated device that reacts to a differential in pressure between the intake and discharge sides of the pump.

The spring tension is set using a pilot valve.

When the pressure exceeds the set pressure, the relief valve opens up and the excessive pressure is redirected to the suction side of the pump.



Relief Valve & Pressure Governors

The pressure governor works differently but the result is still the same. The pressure governor is set based on engine speed.

Once the pressure governor is set, the engine will speed up or slow down to match the highest pump pressure setting.



Relief Valve & Pressure Governors

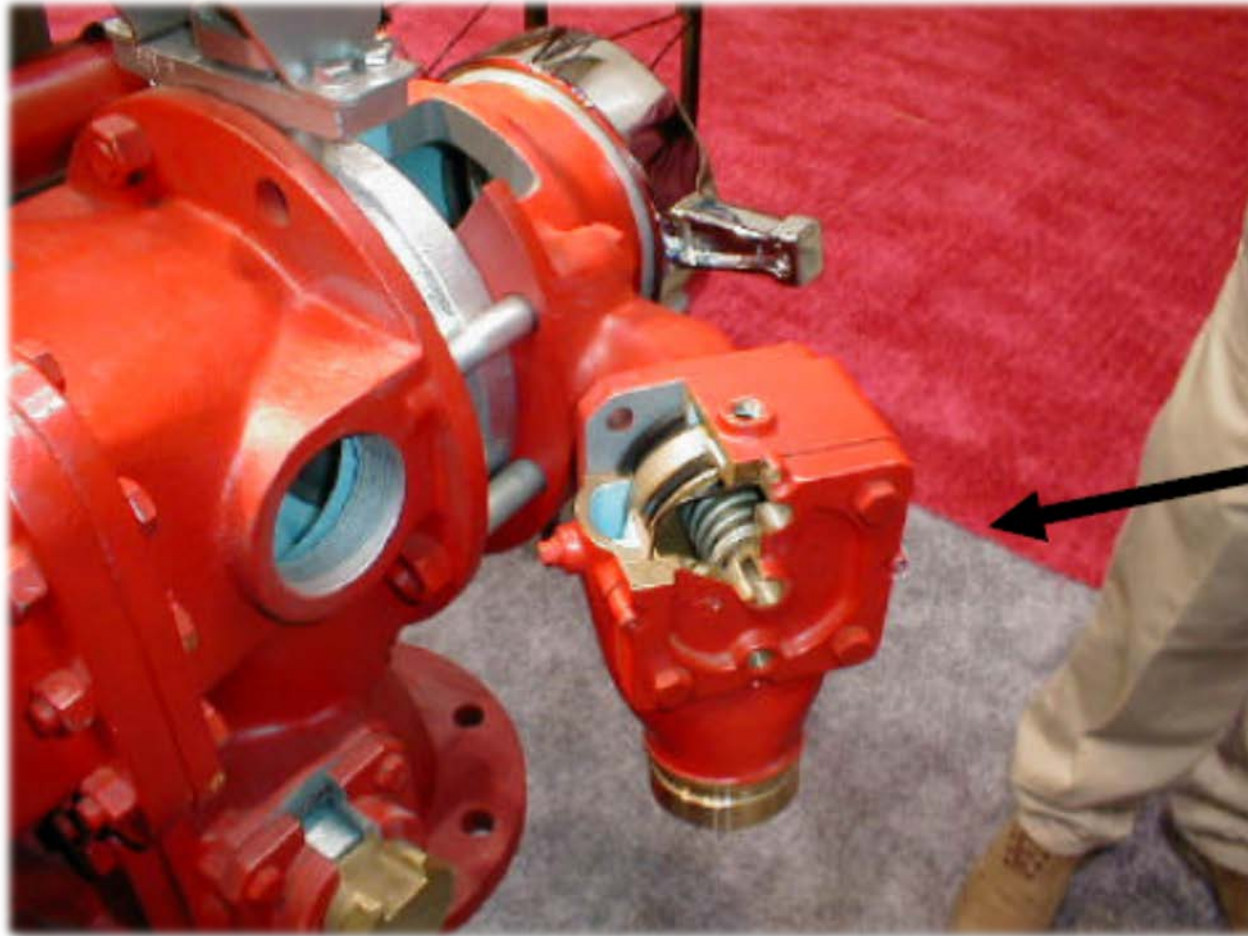

Relief
Valve

Pump Pressure Gauges

We monitor pump operations by using pressure gauges.

The two types of gauges are the **compound gauge (intake)** and the **discharge pressure gauge**.



Compound Gauge

The compound gauge, or intake gauge, is connected to the intake or the suction side of the pump and measures positive intake pressures in psi.

The compound gauge also measures pressures below zero, which is called vacuum. This measurement is in Inches of Mercury (Hg).



Compound Gauge

There is only one compound gauge on the pump panel. However, some pump panels use gauges that have the same face that might look like compound gauges.



Discharge Pressure Gauge

The discharge pressure gauge measures discharge pressure on the discharge side of the pump.

The main discharge pressure gauge measures the discharge pressure at the center of the pump.



Discharge Pressure Gauge

The compound gauge and the main discharge gauge are typically the two largest gauges on the pump panel.



Discharge Pressure Gauge

Each discharge usually has its own discharge gauge which is smaller in diameter than the main pressure gauge.

These smaller discharge gauges measure the pressure at the discharge outlet between the ball valve and the pump panel cover.



Unit 2 – Review

What is the most common type of pump we deal with in the fire service?

Single-stage centrifugal pump

What is the part of the pump that moves water?

Impeller

What is the part of the pump where water enters?

Impeller eye (intake side)

Unit 2 – Review

What is the part of the pump where water is expelled?

Volute

What is the purpose of a priming pump?

To expel air from the centrifugal pump

Why is a priming pump necessary?

Centrifugal pumps cannot pump air

Unit 2 – Review

What does the compound gauge measure?

Intake pressure

When the intake pressure is below zero, the vacuum is displayed in what measurement?

Inches of Mercury (Hg)

What does the main discharge gauge measure?

Discharge pressure at the center of the pump

Unit 3

FRICTION LOSS



Unit Objectives

1. Define Friction Loss.
2. Describe Nozzle Pressure.
3. Describe Engine Pressure and how to calculate it.
4. Describe how to calculate Friction Loss.

Friction Loss

As water moves through a hose the water molecules rub against each other and the side of the hose. When two materials rub against each other, as in this case water rubbing against the inside of the hose, friction is created.

Since we are moving water through a conduit, the friction causes a loss of energy.

Friction Loss

Friction Loss (FL) can best be described as the loss of energy as water moves through a hose. The more water we try to pump through a hose, the greater the friction loss.

We must understand how to calculate how much friction loss we will encounter so we can increase the engine discharge to maintain sufficient water pressure to our firefighters.

Nozzle Pressure

As water exits a nozzle, right at the tip there is a pressure that can be measured with a pitot gauge.

This pressure is known as *Nozzle Pressure (NP)*.

All nozzles are designed to work at specific nozzle pressures.



Nozzle Pressure

The three basic nozzle pressures used in the fire service are:

- Straight tip (hand line) – 50 psi
- Master stream ground monitor with a smooth bore nozzle or stacked tips – 80 psi
- Standard fog nozzles – 100 psi

Check the recommended nozzle pressures of your local nozzles.

Engine Pressure

Engine Pressure (EP) is how much water, in psi, the pump is discharging. This is observed on the Main Discharge Pressure Gauge and is controlled by the pump operator.

Required Engine Pressure (EP) is the sum of the required Nozzle Pressure (NP) plus Friction Loss (FL) plus any elevation and devices.

$$EP = NP + FL$$

Elevation and Devices

- Elevation

Add ½ psi for every one foot of elevation.

Supplying water 40 feet up hill requires the addition of 20 psi.

Similarly, supplying water 40 feet downhill requires the subtraction of 20 psi.

When supplying water to higher floors in a multi-story building, a rule of thumb is to add 10 psi for every floor.

- Devices

When using any device, such as gated wyes, check valves and monitors, add 10 psi for each device.

Friction Loss

To determine friction loss, we need to know three things:

- **Needed flow (in gpm)**
- **Hose size (diameter)**
- **Length of hose line**

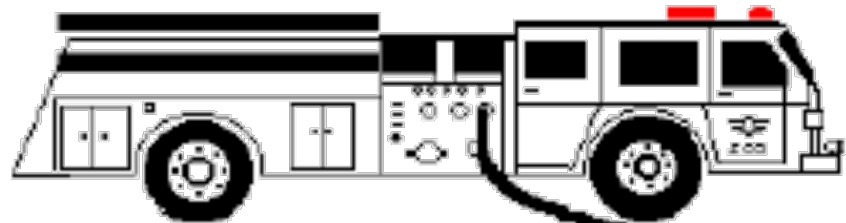

**What Flow
is Needed?**

How Long?

**What Size
of Hose?**

Friction Loss

Required flow, in gallons per minute, is determined by the nozzle. Nozzles are designed to flow specific amounts of water at certain nozzle pressures.



Various Flows Based on Tip Sizes and Nozzle Pressure

Master streams/ Straight Streams		
Tip Size	GPM	@ NP
1 ¼"	400	80
1 3/8"	500	80
1 ½"	600	80
1 ¾"	800	80
2"	1,000	80

Stacked Tip for Master Stream

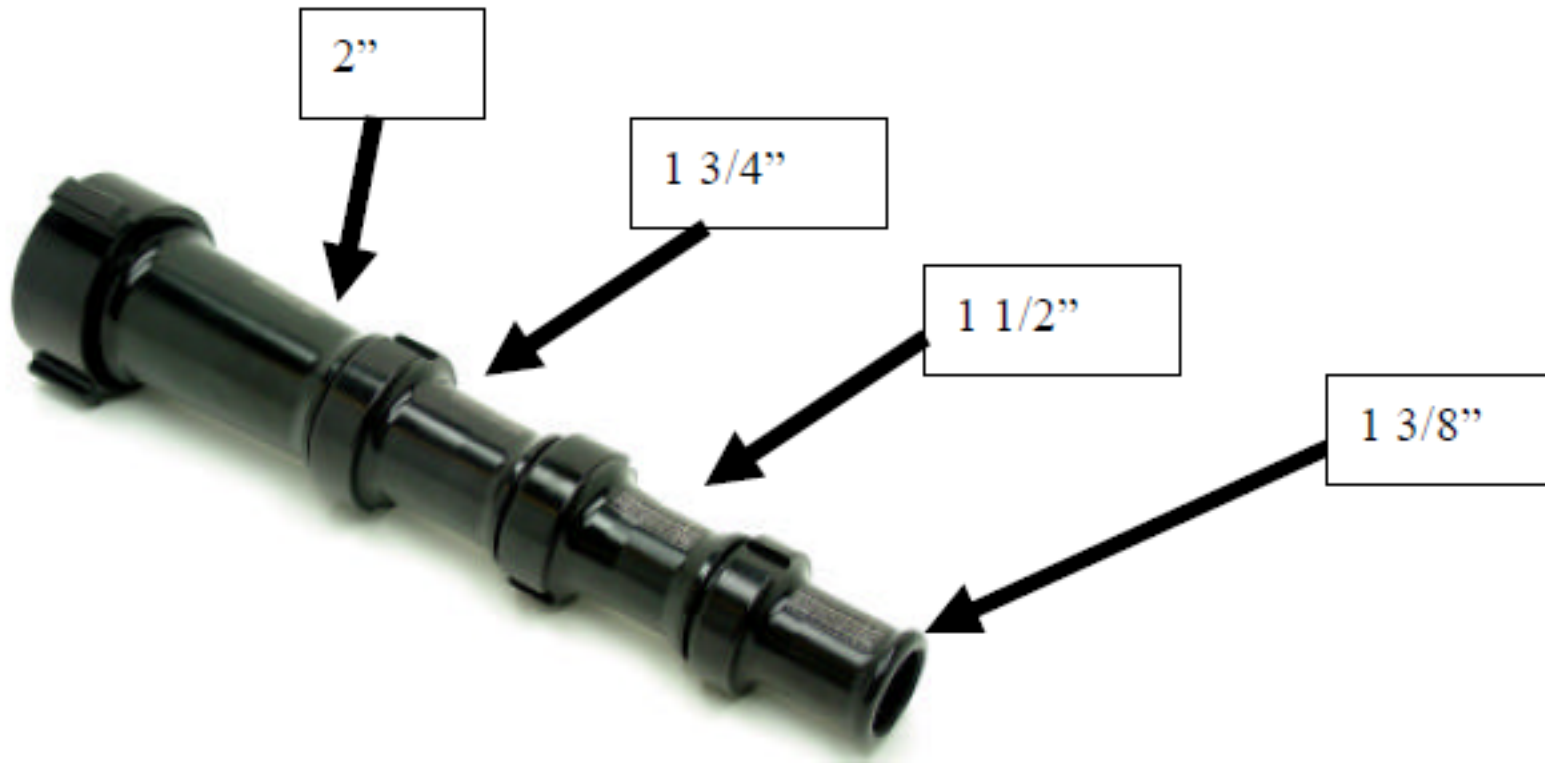

Various Flows Based on Tip Sizes and Nozzle Pressure

Straight Stream/ Hand Line		
Tip Size	GPM	@ NP
15/ 16"	185	50
1"	210	50
1 1/8"	265	50
1 1/4"	325	50

Warning

Engine Pressure should not exceed the test pressure of the hose.

If the test pressure of the hose is not known, do not exceed the following:

- 250 psi for all hose less than 5 inch
- 185 psi for 5 inch hose

Calculating Friction Loss

There are several methods for quickly calculating friction loss.

Some of these formulas are “rule of thumb” formulas.

They are not exact, but they will provide enough accuracy for fireground operations.

These rule of thumb formulas are:

- Drop Ten Method – 2 ½” hose
- Q-Squared Method – 3” hose
- Hand Method – 1 ¾” hose

Drop Ten Method – 2 ½” Hose

The rule of thumb formula for calculating friction loss for sections of 2 ½” hose is the “Drop Ten Method.”

In the illustration, we want to find the Engine Pressure (EP) that is required to provide the proper flow to the nozzle.

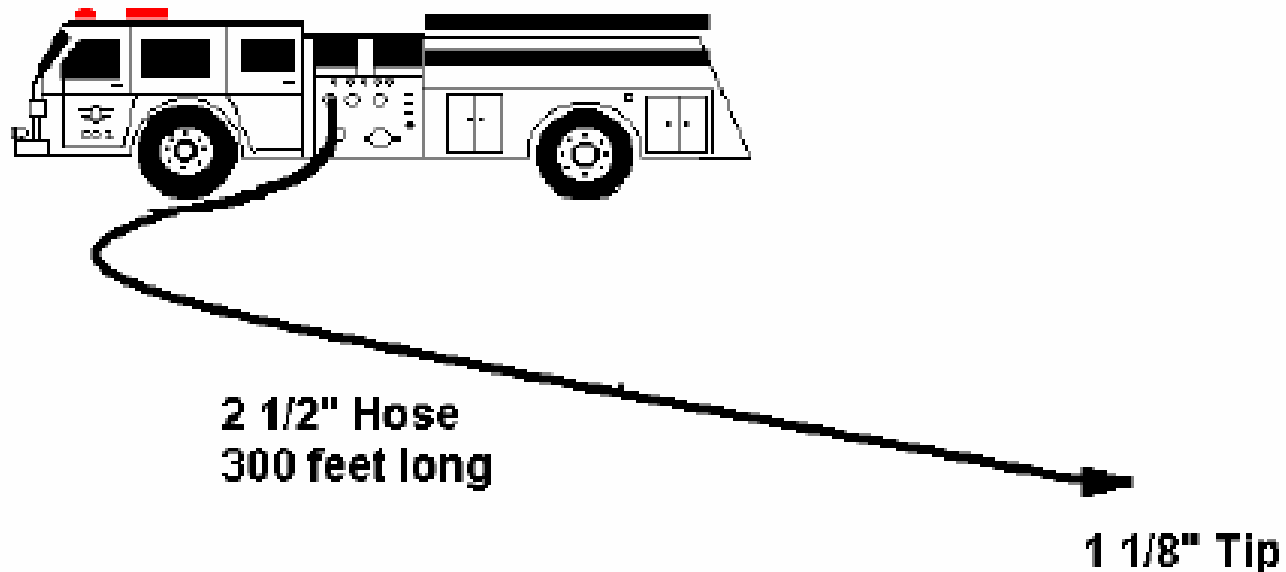

Drop Ten Method – 2 ½” Hose

The illustration gives all of the information needed.

The tip size gives us the flow.

In this case, a 1 1/8” tip, which delivers 265 gpm.



We know the hose size and length.

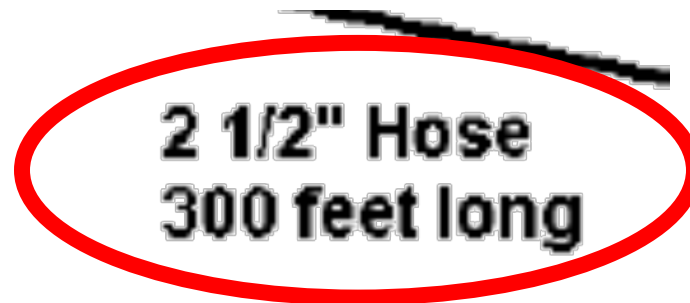

Drop Ten Method – 2 ½” Hose

- To use the Drop Ten Method, we take the flow of 265 gpm and remove the last digit.
- That leaves us with 26.
- Now we subtract 10 from 26 (hence the term drop ten) which leave us with 16.
- This 16 represents the friction loss of 16 psi for each 100 ft of 2 ½” hose.
- In this problem, the total friction loss is 48 psi.

$$\begin{array}{r} 265 \text{ gpm} \\ \text{265} \text{ ~~X~~ } \\ 26 \\ - 10 \\ \hline 16 \text{ psi FL per 100'} \\ \times \underline{3} \text{ for 300' of hose} \\ 48 \text{ psi total FL} \end{array}$$

Drop Ten Method – 2 ½” Hose

- Now add the 48 psi friction loss to the required Nozzle Pressure of 50 psi.

$$\begin{array}{r} 48 \text{ psi total FL} \\ + 50 \text{ psi NP} \\ \hline 98 \text{ psi EP} \end{array}$$

- This gives an Engine Pressure of 98 psi.
- If we pump the engine at 98 psi, we will have 50 psi at the nozzle, and we will be flowing approximately 265 gpm.

Drop Ten Method – 2 ½” Hose

All rule of thumb formulas have limitations.

The Drop Ten Method does not work for flows greater than 400 gpm.



Q-Squared Method – 3” Hose

The Rule of Thumb formula for calculating friction loss for sections of 3” hose is the “Q-Squared Method.”

In the illustration, we want to find the Engine Pressure (EP) that is required to provide the proper flow to the nozzle.

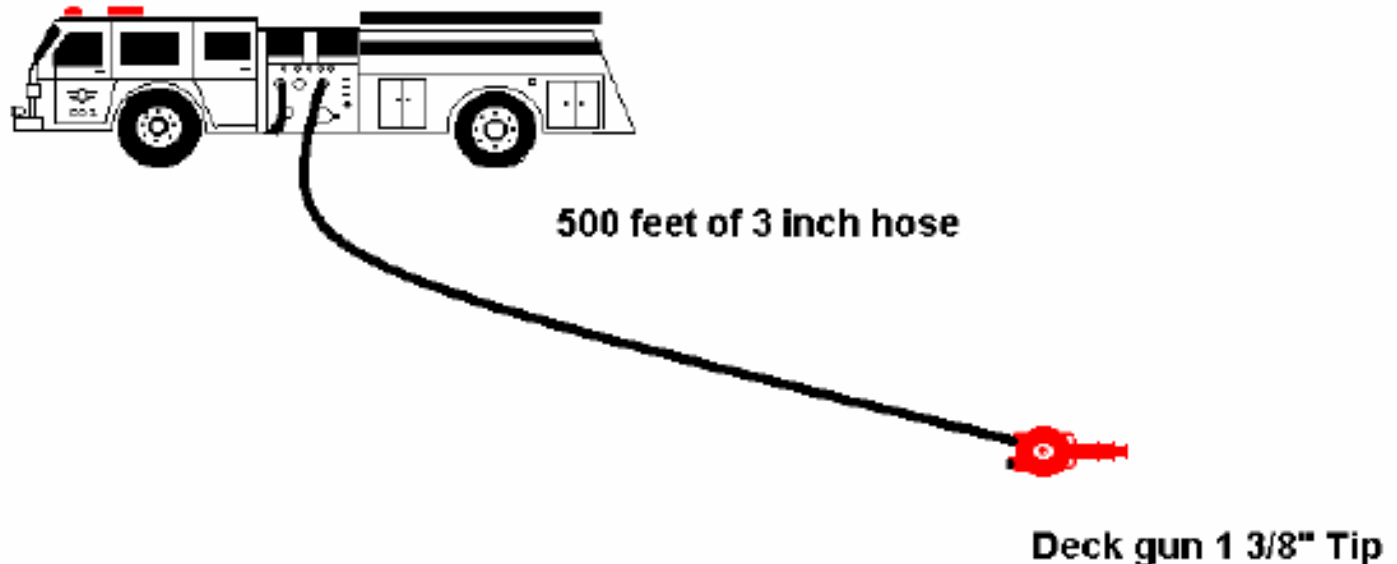

Q-Squared Method – 3” Hose

The illustration gives all of the information needed.

The tip size gives us the flow.

In this case, a deck gun with 1 3/8” tip delivers 500 gpm.



Deck gun 1 3/8” Tip

We know the hose size and length.

500 feet of 3 inch hose

Q-Squared Method – 3” Hose

- To use the Q-Squared Method, we take the flow of 500 gpm and remove the last two digits.
- That leaves us with 5.
- Now we take that 5 and square it (multiply it by itself) which gives us 25.
- This 25 represents the friction loss of 25 psi for each 100 ft of 3” hose.
- In this problem, the total friction loss is 125 psi.

500 gpm

~~500~~

5

x 5

25 psi FL per 100'

x 5 for 500' of hose

125 psi total FL

Q-Squared Method – 3” Hose

- Now add the 125 psi friction loss to the required Nozzle Pressure of 80 psi.
- Add 10 psi for the device (deck gun).
- This gives an Engine Pressure of 215 psi.
- If we pump the engine at 215 psi, we will have 80 psi at the nozzle, and we will be flowing approximately 500 gpm.

$$\begin{array}{r} 125 \text{ psi total FL} \\ 80 \text{ psi NP} \\ + 10 \text{ psi device} \\ \hline 215 \text{ psi EP} \end{array}$$

Q-Squared Method – 3” Hose

The Q-Squared Method does not work for flows greater than 700 gpm.



1 ¾" Hose

1 ¾" hose has become one of the most widely used fire attack hose lines. This is due largely in part to the flow rate and maneuverability of this hose.

A regular fire flow for residential structure fires is 150 gpm. The 1 ¾" hose can flow up to 200 gpm.

1 3/4" Hose

Many 1 3/4" hose lines are pre-connected to the apparatus. This means that a set length of hose, such as 150 feet or 200 feet, is connected to a discharge on the apparatus.

This can make things easier for a pump operator because based on the nozzles and hose lengths, a set engine pressure can be established without the need for any calculations.

However, if the pre-connected line is not enough, then it has to be extended and now we have to calculate more friction loss.



Hand Method – 1 3/4" Hose

The Rule of Thumb formula for calculating friction loss for sections of 1 3/4" hose is the "Hand Method."

- To use the hand method, we first need to know the flow in gpm.
- The flow is shown in the illustration and has a corresponding thumb or finger.

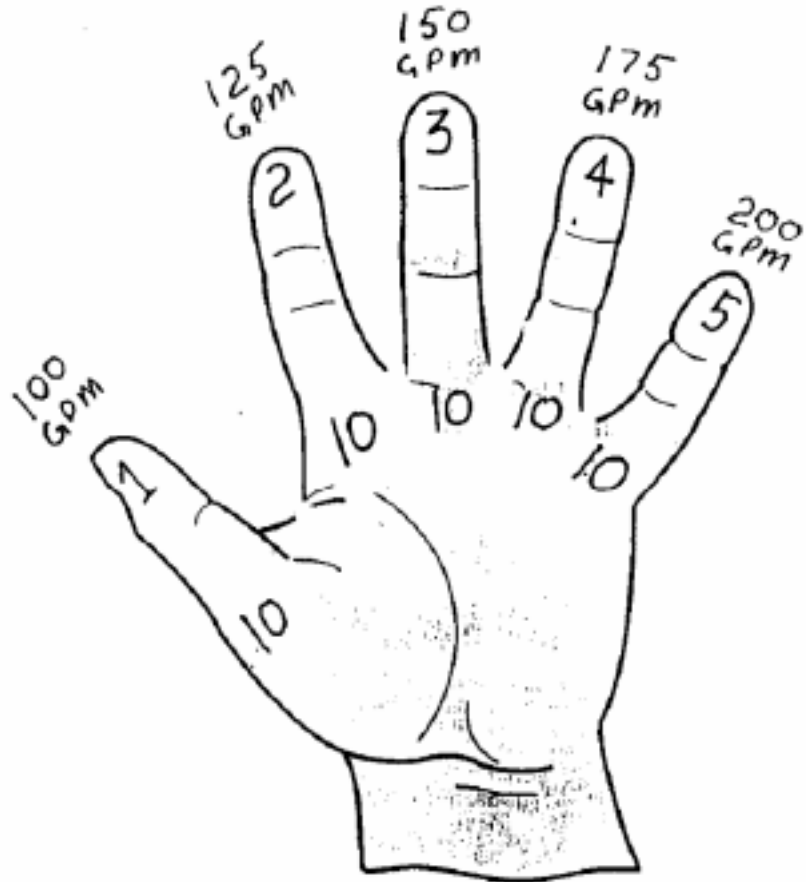

Hand Method – 1 ¾” Hose

- If we want to flow 150 gpm, we can see that the middle finger is assigned 150 gpm and also the number 3.
- All we need to do is take the number 3 and multiply it by 10.
- $3 \times 10 = 30$
- This gives a friction loss of 30 psi for every 100 feet of 1 ¾” hose when we are flowing 150 gpm.

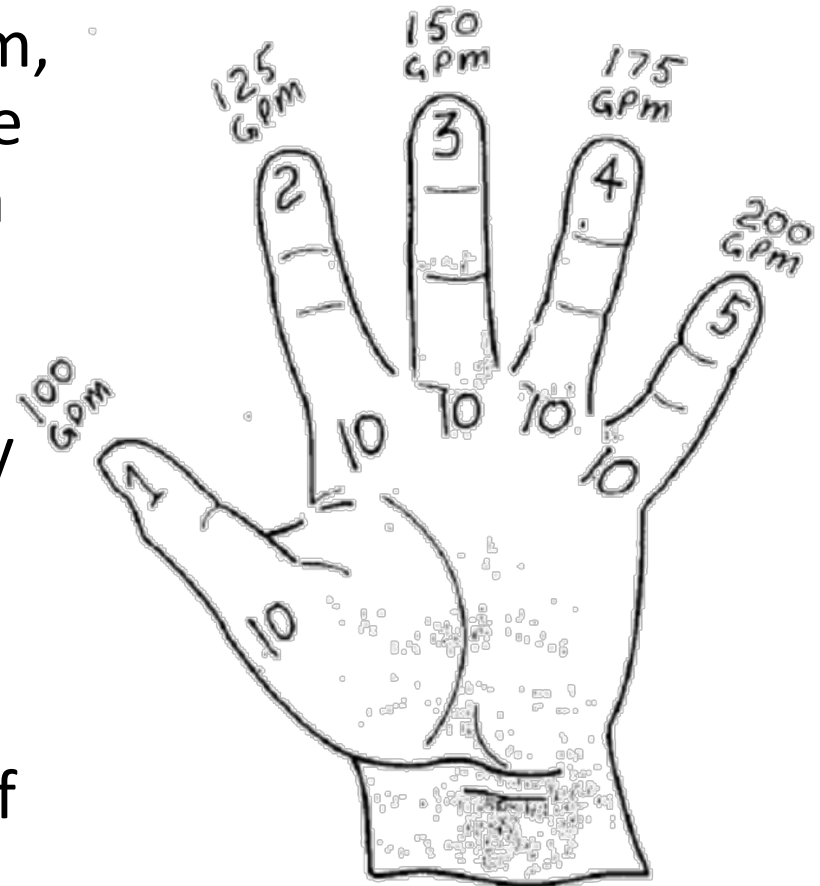

Hand Method – 1 3/4" Hose

- If we want to flow 200 gpm, we can see that the pinky finger is assigned 200 gpm and also the number 5.
- All we need to do is take the number 5 and multiply it by 10.
- $5 \times 10 = 50$
- This gives a friction loss of 50 psi for every 100 feet of 1 3/4" hose when we are flowing 200 gpm.

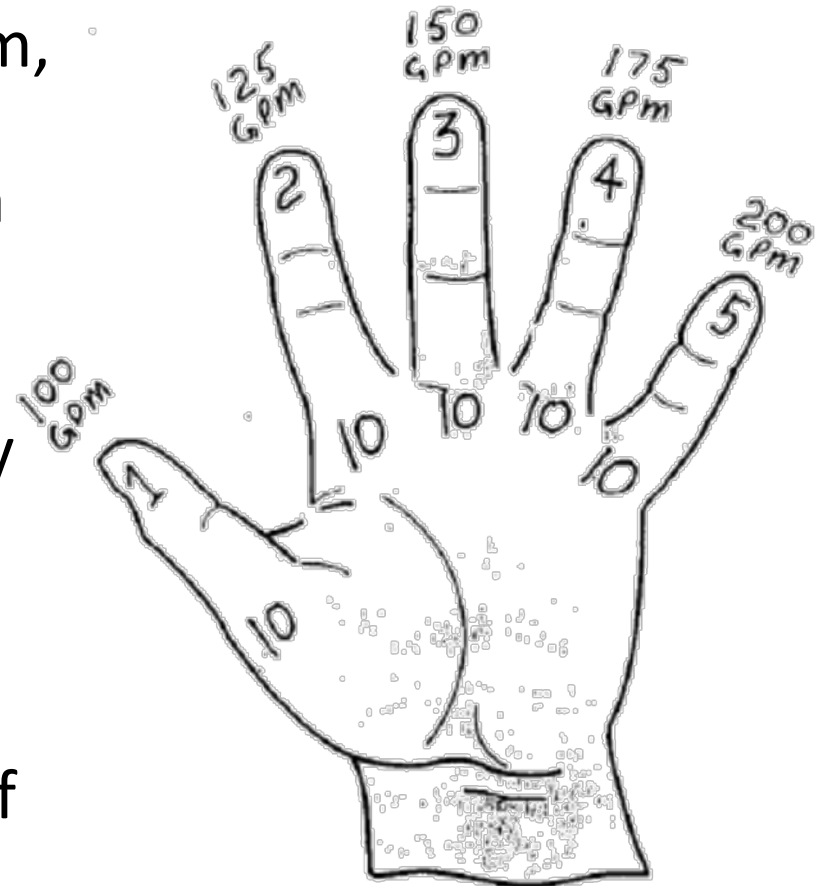

Friction Loss Comparison Table

The table shows the friction loss comparisons between the three hose sizes we discussed.

You can see that the larger the hose, the lower the friction loss.

You can also see that as the flow increases, the friction loss also increases.

Based on 100 Ft. of Hose			
Gpm	FL 1 3/4"	FL 2 1/2"	FL 3"
100	10 psi		
125	20 psi		
150	30 psi	5 psi	
175	40 psi	7 psi	
200	50 psi	10 psi	4 psi
250	na	15 psi	6 psi
300	na	20 psi	9 psi

Unit 3 – Review

What is Friction Loss?

The loss of energy as water moves through a hose

What Nozzle Pressure is required of most standard fog nozzles?

100 psi

What is the basic formula for calculating how many psi to supply from the engine (Engine Pressure)?

Engine Pressure (EP) = Nozzle Pressure (NP) +
Friction Loss (FL) + any elevation and devices

Unit 3 – Review

How many psi are incurred by elevation?

½ pound for every one foot of elevation

How much friction loss is incurred by each device, such as a wye, check valve or monitor?

10 psi

Engine pressure should not exceed what?

Test pressure of the hose being supplied

Unit 3 – Review

What is the rule of thumb method for calculating friction loss in 2 ½” Hose?

Drop Ten Method

What is the rule of thumb method for calculating friction loss in 3” Hose?

Q-Squared Method

What is the rule of thumb method for calculating friction loss in 1 ¾” Hose?

Hand Method



Unit 4

OPERATIONAL PRACTICES

Unit Objectives

1. Identify operational practices for
 - booster tank operations
 - operating from fire hydrants
 - drafting operations

Booster Tank Operations

These operational practices are for general instruction. Check your local pumper user's manual for specific operational procedures and limitations.

Additional training may be required.



Booster Tank Operations

The majority of fire department operations are handled with the use of the booster tank.

When working from the booster tank, the pump operator should follow the appropriate steps:



Booster Tank Operations

1. Park the apparatus in a position that assumes the best tactical advantage for the situation.
For example: Car fire – park uphill and upwind.
Park facing your exit route.
Don't forget to set the parking brake and chock the wheels.
2. Put the apparatus in pump gear and check for “okay to pump” indication.
3. Check to see what line has been taken off the apparatus and make sure the hose is flaked out.

Booster Tank Operations

4. Open the Tank to Pump valve and engage the primer for a few seconds (if needed) until the pump is primed. Open the desired gate valve and throttle up to the desired engine pressure.
5. When in pump gear the pump should not be allowed to operate without water for any length of time. Water must be circulated. This can be done via the Tank to Pump and Tank Fill valves or by using a circulating valve.

Booster Tank Operations

6. Slowly open the desired discharge valve.
7. Increase throttle control to the desired pressure.
8. Set pressure control devices, if used.



Booster Tank Operations

Shutting Down Procedures

1. Reduce throttle control to idle.
2. Close discharge valves.
3. Make sure tank is full of water, per your departmental policy.
4. Close intake valves.
5. Place transmission in neutral.
6. Wait for engine speedometer to go to zero.
7. Operate pump shift device.

Operating from Fire Hydrants

Some situations require using a fire hydrant for water supply.

There are two basic types of hydrants:

- Wet barrel
- Dry barrel

We typically use dry barrel hydrants throughout Texas.



Operating from Fire Hydrants

With dry barrel hydrants, the plunger, which opens and closes when the stem is turned, is located underground at the main level.

When the hydrant is closed, the water in the barrel drains out of the hydrant into the ground

This prevents the hydrant from freezing and being damaged in freezing temperatures.

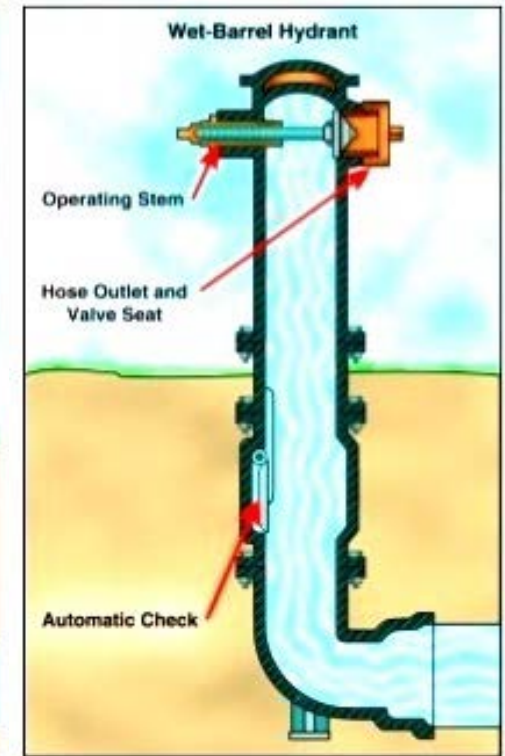
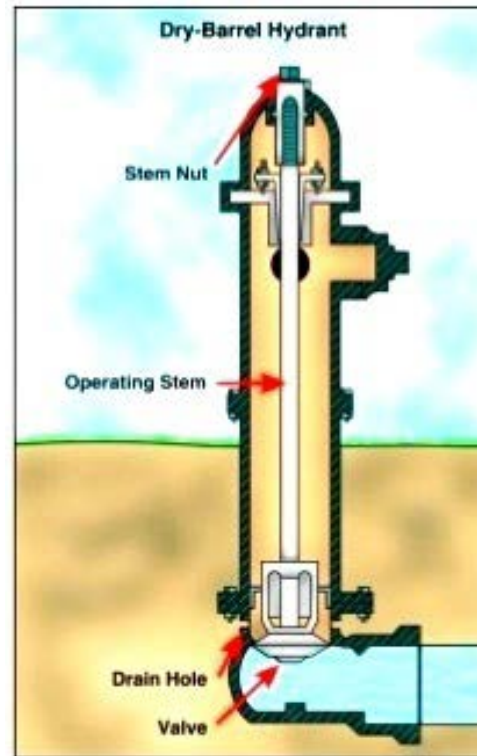

Operating from Fire Hydrants

When the hydrant is open, the drain is closed off and the water fills the barrel.

This is why it is important when using a hydrant to open it all the way. **If the hydrant is not fully open the drain is not closed off.**

It is recommended to attach a gated valve at the hydrant so you can leave the hydrant fully open.



Operating from Fire Hydrants



Drain holes located at the base of the hydrant.

Operating from Fire Hydrants

Depending on the size of the fire, the hydrant selected to supply the firefighting operation should be of sufficient volume. This means if the fire requires a 1,000 gpm flow, hooking up to a hydrant that only flows 500 gpm will be of little use for extinguishment.

You should attempt to connect to a hydrant that will give an adequate flow.

This may not always be possible depending on the water system in the area of the fire.

Operating from Fire Hydrants

Check the size and type of connections of the hydrants in your area.

What size connections do your hydrants require?

Do you have the proper fittings on your pumper?



Operating from Fire Hydrants

When working from a hydrant, always take the extra minute to hook up for maximum supply. This means hook up with the 5 inch soft suction hose and, if possible, *put a gate valve on the hydrant.*

Two things to watch out for when working with a hydrant:

- Always note the static pressure on the compound gauge before flowing any water.
- Try not to let the intake pressure on the compound gauge drop below 20 psi.

This is your safety zone. If the intake pressure dips below this, it is an indication that you may be running out of your water supply.

Drafting Operations

Drafting is the term used when we take our water supply from a static water source such as a lake, pond, river, drop tank, etc. To understand how drafting works we need to have a basic understanding of atmospheric pressure and priming devices.

Simply put, when we draft water from a static source we are using a priming pump to create a vacuum in the main fire pump. The atmospheric pressure then pushes the water up the suction hose and into the pump.



Drafting Operations

To start a drafting operation, the following procedure is recommended:

1. Pick a spot suitable for the apparatus.
 - Position apparatus as near as possible to water source.

**Remember to set
the parking brake
and chock the
wheels!**



Drafting Operations

It is important to understand that there is a limit to the height of lift when drafting. Optimum usage is within 10 ft vertical lift.

A fire pump in good condition can only be expected to lift water no more than 25 feet.



Drafting Operations

2. Remove the required lengths of hard suction hose and put them together tightly.



Use the least number of segments as possible.

Drafting Operations

3. Attempt to tie off the strainer with a rope. It is important to keep the strainer off the bottom. This should prevent the strainer from getting jammed in the mud and clogging. Some departments use a float dock strainer.
 - Attempt to keep the strainer 24 inches under the surface of the water. This should prevent whirlpools.



Drafting Operations

4. Attach suction hose to pump.
 - Suction hose should be even with or lower than the intake.
 - Ensure that all connections are tight.
 - Ensure all drains and valves on the intake side of the pump are closed.
 - Use the front or opposite side intake, if possible (front intake piping reduces capacity).

- Ensure you have a means for water circulation.

Drafting Operations

5. Place pump in gear in accordance with transmission instructions. With the apparatus in pump gear and an “Okay to Pump” signal, increase the engine’s rpms.
6. Engage the primer.
 - Use primer until steady stream of water flows from the primer discharge hose.
 - Watch for pressure reading on discharge gauge and vacuum on the compound gauge.
7. Once draft has been established and water is in the pump, open circulation valve.
8. Open discharge valves slowly while increasing throttle to maintain or increase pressure.

Drafting Operations – Troubleshooting

If pump fails to prime, check the following:

1. Air leaks
2. Debris on strainer
3. Oil level low in priming tank
4. Defective priming valve
5. Drafting lift too high
6. Not enough water above strainer – may cause whirlpooling
7. Hard suction hose higher than intake
8. Primer not activated long enough

Unit 4 – Review

When parking an apparatus for pumping operations, what two procedures should always be taken?

Set the parking brake and chock the wheels

What happens if you do not open a dry barrel hydrant all the way when using it as a water source?

Some water will drain out through the drain holes

Once the pump is primed with water, why should you open the discharge slowly?

Because a sudden loss of pressure due to quickly opening the discharge may result in the loss of prime

Conclusion

Simply, the fundamental order of providing water through a pump is:

1. Power – ensure the pump has power to operate
2. Water – ensure you have an adequate water supply
3. Prime – expel air from and supply water to pump
4. Discharge – deliver water in sustainable amounts

Each apparatus may have specific processes to follow in order to operate, and additional training specific to your apparatus may be necessary.

For More Information

For information regarding pumper operations training in Texas, go to tiwa.tamu.edu and contact your local Regional Fire Coordinator: tfsweb.tamu.edu/RFC

For suggestions or corrections for this course, please contact

Texas A&M Forest Service
Incident Response Department
Training Section
training@tfs.tamu.edu